

Reliable Functions Developed by  
the Specialized Valve Manufacturer

Easy Installation

Low Cost

Safe and Secure

**New Product!**

## Operation Recording Unit for Quarter-turn Valves

**Tom Probe** Series

Recording the valve's operation 24  
hours a day, 365 days a year

**TPro1100** <Unit main body>

Configuring various settings and  
collecting data using a PC

**TPro1900** <Application>

Achieving centralized control and  
status monitoring

**TPro1700** <Remote control unit/Option>



TPro1100



TPro1700

# The unit monitors the valve operation and quickly detects abnormalities.

The TPro1100/TPro1900/TPro1700 units, developed by Tomoe Valve, are new devices which record the operational status of quarter-turn valves automatically, 24 hours a day, 365 days a year. TPro1100 quickly detects abnormalities and defects in the valves, and notifies these externally, via various interfaces.

TPro1100 is also equipped with a new function, ASF (Active Safety Function) which performs partial stroke tests periodically, based on the unit's calendar.

Please make full use of the reliable operation recording units, which draw on the technologies and know-how of the specialized valve manufacture, TOMOE.

The operational status data of the valve is saved in the TPro1100 (unit main body) and can be read using a PC.

When the TPro1700 (Remote control unit/Option) is also fitted, a maximum of 15 TPro1100 units can be installed. Management and recording of valves located in remote places becomes easy.

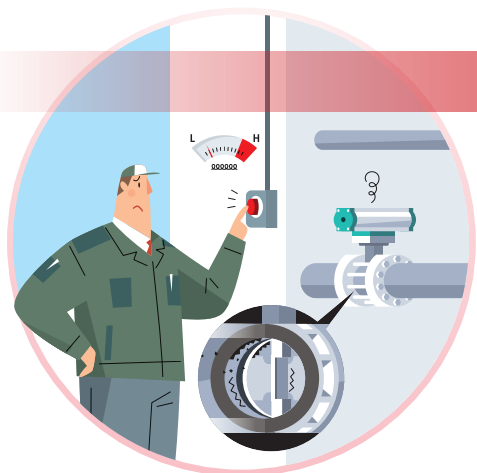

## Typical Problems of Valve Control

- A valve is in bad shape, but we are not sure of the cause...
- We don't have time to stop the line, disassemble and check the valve...
- If the valve is repaired, the repair will be expensive. What should we do?

Before abnormalities or defects of valves occur

## Introduction of TOMOE units

## Major Advantages

- Operational data on the valve is recorded all the time. Unexpected defects can be detected at an early stage.
- The unit can be operated without specialized knowledge and skills.
- The unit can be easily installed to existing valves.

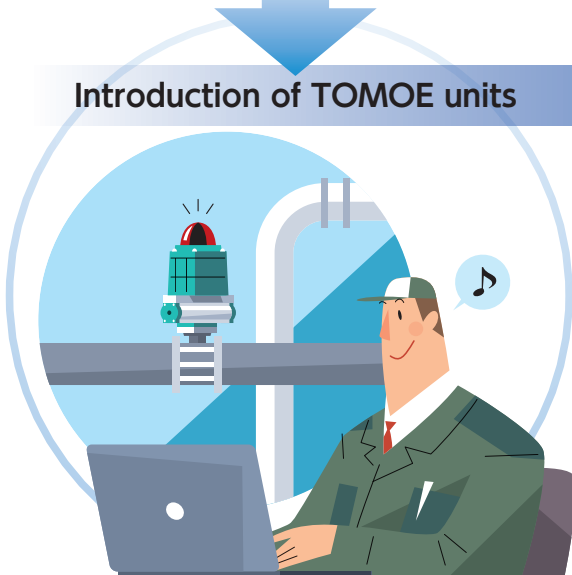

## Major Features

- Suitable for control and data-recording of air cylinder automatic valves  
\*The unit can be used for quarter-turn valves (including butterfly valves and ball valves).
- The unit can be fitted with newly installed valves or retrofitted.
- Input power supply is AC100V - 240V, 50Hz/60Hz.  
The unit can be used in many overseas countries.
- The operational status data of a valve is saved in the unit main body.
- The unit has advanced functions, such as partial stroke test (PST) and active safety function (ASF).



# Recording the Valve Operation 24 Hours a Day, 365 Da

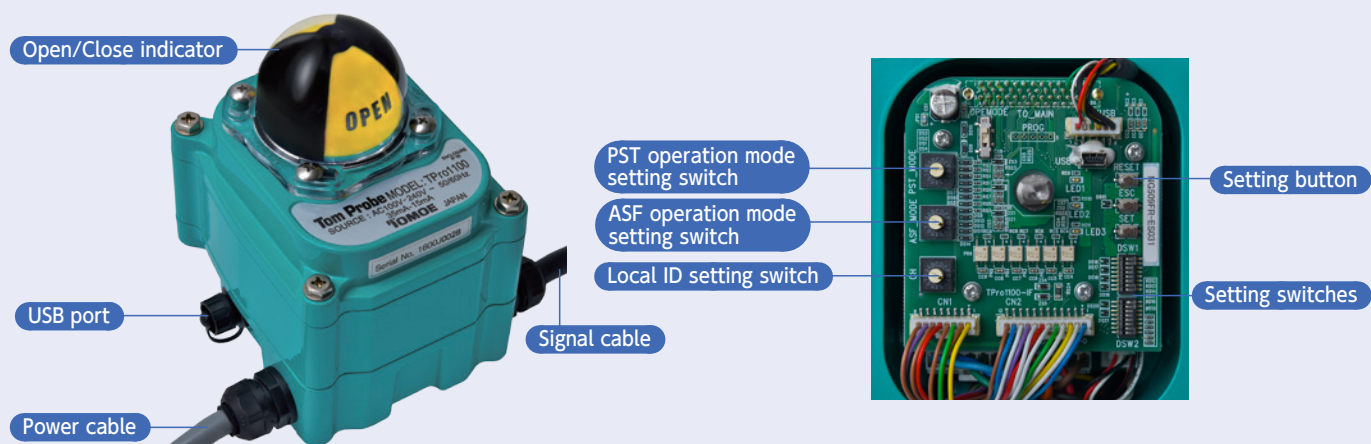

## Basic Features

### Three Modes

The unit has three modes which can be selected according to the installation and control status of a valve.

<b>Control recording</b>	Operation mode for recording the open/close control of a valve and the operational status of a valve in order to perform open/close control and various tests
<b>Data logger</b>	Operation mode for recording the operational status of a valve which is controlled by devices other than this unit
<b>Setting</b>	Mode for creating settings for various kinds of operation recording

### Wiring and Control

The unit has various control and output interfaces, and can be applied to both newly installed valves and retrofitted.

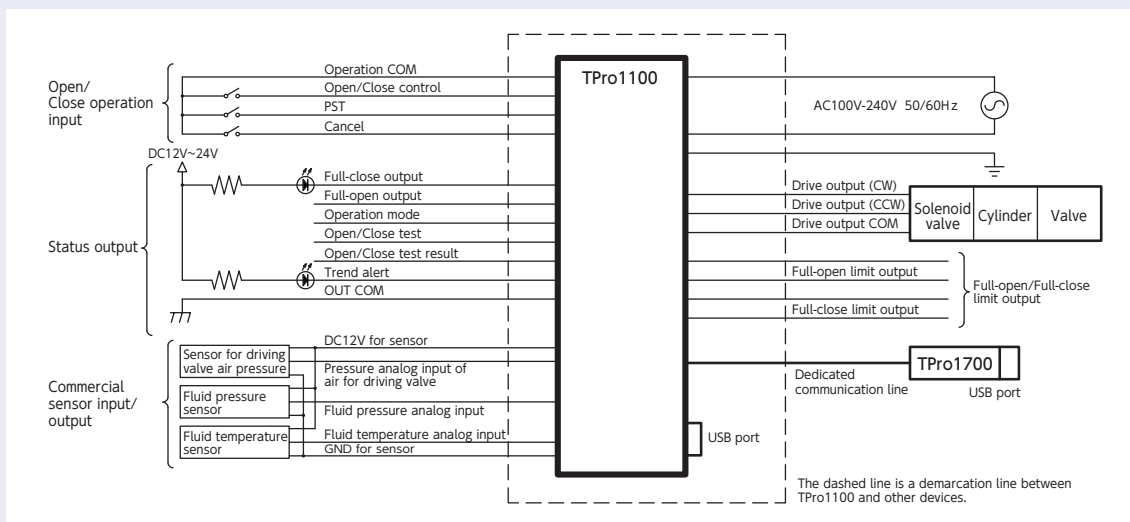

### Wide-range power supply input

**Power supply in overseas countries is supported.**

Input power supply is AC100-240V, 50Hz/60Hz.  
The unit can be used in many overseas countries.

### Status Output

**The unit transmits the status of the devices in detail.**

The unit outputs open/close status, operation mode, abnormal status, etc. from the recording unit to external control devices, such as sequencers. The status of the devices can be transmitted in detail by altering settings in the main body.

Full-close output	Full-open output	Operation mode output	Open/Close test output	Open/Close test result output	Trend alert output
-------------------	------------------	-----------------------	------------------------	-------------------------------	--------------------

\*The unit has full-open and full-close limit output in addition to the above-mentioned status output, and can drive loads up to AC250V5A, DC30V5A.

## Recording Function/Test Function

### Trend Recording

### Recording the valve operation 24 hours a day, 365 days a year

The unit records the operational status of the valve all the time. If any abnormal value is detected, the unit provides notification of the abnormality through external output or communication.

日付	時間	子一区分	評価結果	閉時間+開時間 (ms)	閉時間 (ms)	開時間 (ms)	駆動空気圧力 (%)	流体圧力 (%)	流体温度 (%)
2016/9/15	18:00:25	閉	閉初期特性値取得中	1300	1300	0	51.0	31.0	21.0
2016/9/15	18:02:27	閉	閉初期特性値取得中	1300	1300	0	51.0	30.0	20.0
2016/9/15	18:03:14	閉	閉初期特性値取得中	1280	1280	0	50.0	29.0	21.0
2016/9/15	18:04:12	閉	閉初期特性値取得中	1280	1280	0	50.0	29.0	19.0
2016/9/15	18:10:00	閉	閉初期特性値取得中	1300	1300	0	51.0	31.0	20.0
2016/9/15	18:14:04	閉	閉初期特性値取得中	1290	1290	0	51.0	30.0	21.0
2016/9/15	18:18:08	閉	閉初期特性値取得中	1290	1290	0	51.0	30.0	20.0
2016/9/15	18:22:12	閉	閉初期特性値取得中	1290	1290	0	50.0	31.0	20.0
2016/9/15	18:26:16	閉	閉初期特性値取得中	1290	1290	0	49.0	31.0	20.0
2016/9/15	18:30:20	閉	閉初期特性値取得中	1280	1280	0	51.0	30.0	19.0
2016/9/15	18:34:24	閉	閉初期特性値取得中	1280	1280	0	50.0	29.0	19.0
2016/9/15	18:38:28	閉	閉初期特性値取得中	1290	1290	0	51.0	29.0	19.0
2016/9/15	18:42:32	閉	閉初期特性値取得中	1290	1290	0	49.0	31.0	20.0
2016/9/15	18:46:37	閉	閉初期特性値取得中	1290	1290	0	49.0	31.0	19.0
2016/9/15	18:50:41	閉	閉初期特性値取得中	1280	1280	0	51.0	30.0	20.0
2016/9/15	18:54:45	閉	閉初期特性値取得中	1290	1290	0	50.0	29.0	20.0
2016/9/15	18:58:49	閉	閉初期特性値取得中	1280	1280	0	49.0	29.0	20.0
2016/9/15	19:02:53	閉	閉初期特性値取得中	1280	1280	0	51.0	31.0	19.0
2016/9/15	19:06:57	閉	閉初期特性値取得中	1290	1290	0	51.0	29.0	20.0
2016/9/15	19:11:01	閉	閉初期特性値取得中	1280	1280	0	49.0	30.0	21.0
2016/9/15	19:15:05	閉	閉初期特性値取得中	1280	1280	0	50.0	30.0	21.0
2016/9/15	19:19:09	閉	閉初期特性値取得中	1290	1290	0	49.0	31.0	19.0
2016/9/15	19:23:13	閉	閉初期特性値取得中	1290	1290	0	50.0	29.0	19.0

Test Items
Open/Close +50% over error
Open/Close -50% over error
Open/Close + over error
Open/Close - over error
TA open time over
TA close time over
PST/ASF not reached set angle
PST/ASF timeout

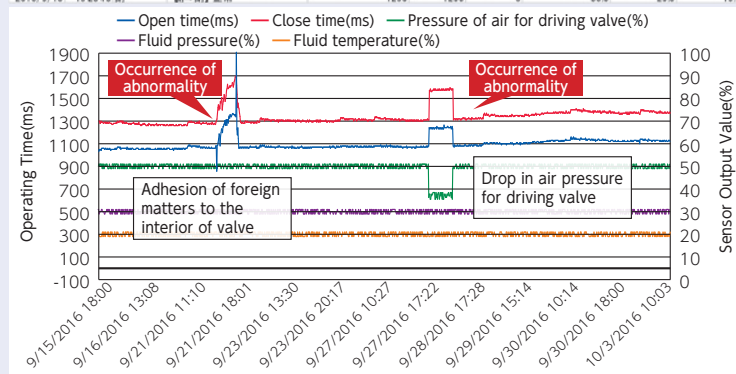

### Graphing

Graphing the trend data recorded by "TPro1100", using commercial spreadsheet software, allows the operational status of the valve to be viewed more easily.

\*Graphing the recorded data requires commercial spreadsheet software, etc.  
\*The values of the recorded data shown here are examples, to explain the function of this unit.

### Various Recording Modes

### The operational data at opening/closing and in tests is saved in the main unit.

8000 or more units of data can be saved. Values including opening/closing time and commercial sensors (maximum three) can be recorded. The unit has three modes for various tests.

<b>Continuous Mode</b>	When the memory is full, the oldest data is overwritten by new data.
<b>One Shot Mode</b>	When the memory is full, recording stops.
<b>New Function Accumulation Mode</b>	When the memory is full, old data will be reduced, and new data will be saved. Original recording system where new data is accumulated while old data is kept.

### Three Commercial Sensor Inputs

### Recording three values which give clues to valve abnormality diagnosis.

The unit can capture analog output values from three commercial sensors for temperature, fluid pressure and driving valve air pressure.

This allows valve status to be checked in various aspects.

Supported input from sensors is 0 - 20mA or DC0-5V

### Partial Stroke Test (PST)

### Test function of valve operation is equipped.

Partial stroke test (PST) is a test method to check the operational status by opening and closing the valve a little. The test can be performed by combining a solenoid valve for driving a cylinder with the "TPro1100". Additionally, ASF function which performs the partial stroke test automatically based on the calendar in the "TPro1100" is inbuilt.

The opening/closing test interval can be selected between every day, every week, and every month.

		Timeout Time		
		5s	20s	60s
Operation Angle	10%	Mode1	Mode2	Mode3
	25%	Mode4	Mode5	Mode6
	50%	Mode7	Mode8	Mode9
	100%	Mode10	Mode11	Mode12

Step1 Configure the test conditions using the switches on the circuit board.

Step2 Start the test performance by signal input from the I/O switch or a remote control unit.

For Mode 4  
Operation should be completed within 5 seconds.

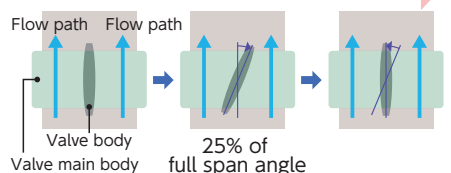

Switches on the Circuit Board



# Various Settings and Data Collection Controlled with a PC

## TPro1900 (Application)

Application "TPro1900" is a freeware program which allows configuration of various settings for the unit main body "TPro1100", and allows control of a maximum of 15 units of "TPro1100".

### Integrated Management Function

The application displays information of all "TPro1100" units in the network in list form. The indicator lamps on the screen also allow checking of open/close status, trend evaluation results, and open/close test results of the managed valves.

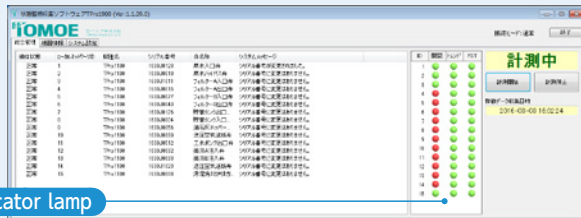

Indicator lamp

### Device Information

Valve name, date and time can be set in the main body, etc. Additional information, including total operating time and the number of opening/closing, which is required for planning of maintenance, is also available.

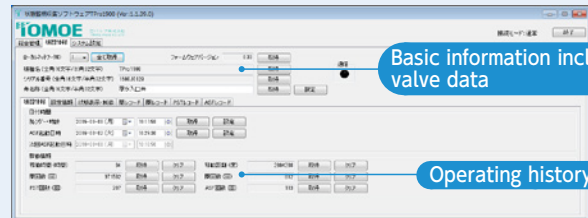

Basic information including valve data

Operating history data

### Setting Information

Standard values learned by the "TPro1100" and various settings can be checked. Conditions of the partial stroke test and the adhesion prevention test can be configured. In addition, it is easy to check the "TPro1100" settings, such as the presence of the sensor connected to the "TPro1100", data accumulation mode, detail of outputs to the external devices, simply preventing incorrect settings being used.

### Remote Data Collection

The valve operation data accumulated in the "TPro1100" can be collected from a remote area when used in conjunction with the "TPro1700" (Remote control unit/Option). The status of valves located in difficult-to-access areas can be kept track of easily.

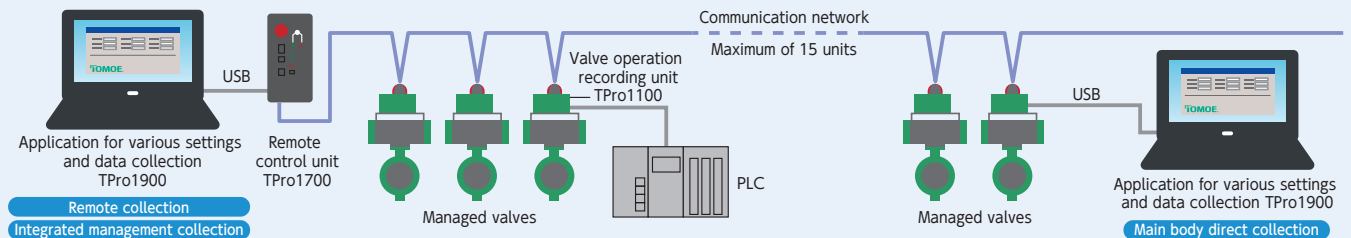

Remote collection  
Integrated management collection

Main body direct collection

# Achieving Centralized Control and Status Display

## TPro1700 (Remote control unit/Option)

### Relay Function

The unit has a function for creating a communication network, connecting the "TPro1100" main body unit to a PC with the "TPro1900" application installed. A maximum of 15 "TPro1100" units can be controlled.

### Saving on Wiring

Installation requires only two cables for communication and a power supply cable to the unit.

### Reduced Installation Costs

Since the unit is equipped with control switches and LED status display lamps, no separate control board is required.



## Specifications

Item	TPro1100	TPro1700
Attachment shape	VDI/VDE3845 Rotary Actuators(Quarter-turn)and Auxiliary Equipment	Attachment with various stays
Dust-proof and waterproof	IP65 equivalent	
Conduit tube connection	500 mm length for both power supply cable and communication cable	
Main body main material	Aluminum die-casting	Main body: ABS resin
Display function	Open/Close indicator	LED open/close indication, power indicator lamp, test result indication, controlled unit ID 7-segment indication
Power supply voltage	AC100V-AC240V Single-phase 50/60Hz	
Ambient operating temperature	-20°C - 80°C (No condensation)	-20°C - 50°C (No condensation)
Ambient storage temperature	-20°C - 80°C (No condensation)	-20°C - 60°C (No condensation)
Interface specifications	<ul style="list-style-type: none"> <li>◆ I/O contact input/output (Open/close instruction, PST instruction, status output)</li> <li>◆ Analog input (3 points for sensors)</li> <li>◆ TOMOE's dedicated communication (RS485)</li> </ul>	<ul style="list-style-type: none"> <li>◆ Switch input (Open/close instruction, PST instruction)</li> <li>◆ Compliance with USB standards</li> <li>◆ TOMOE's dedicated communication (RS485)</li> </ul>
Functions	<ul style="list-style-type: none"> <li>◆ Solenoid valve direct drive function</li> <li>◆ PST function (One mode out of 13 modes is selected.)</li> <li>◆ ASF function (One mode out of 13 modes is selected.)</li> <li>◆ Trend data logging function (8000 data for each Open, Close, PST and ASF are held in the main body.)</li> </ul>	<ul style="list-style-type: none"> <li>◆ Communication gateway function (USB-RS485)</li> <li>◆ Supply of operation instructions to a selected unit</li> </ul>

## External Dimensions

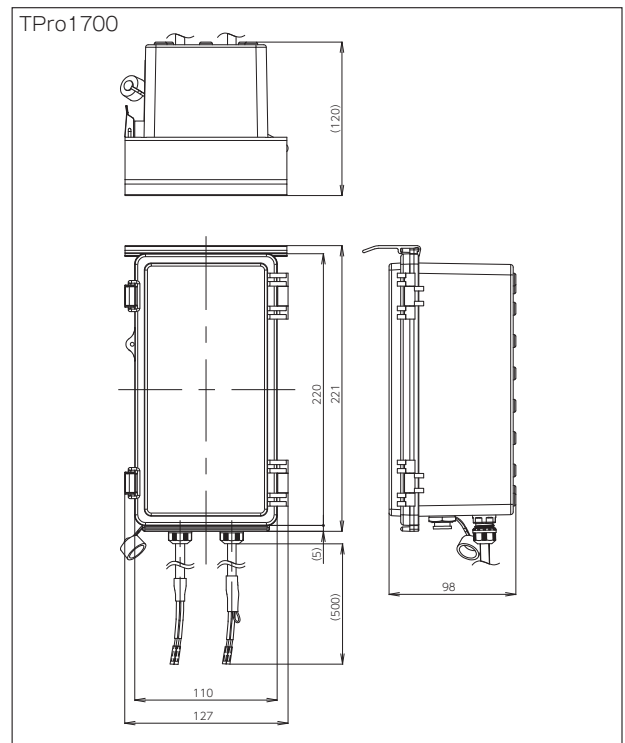
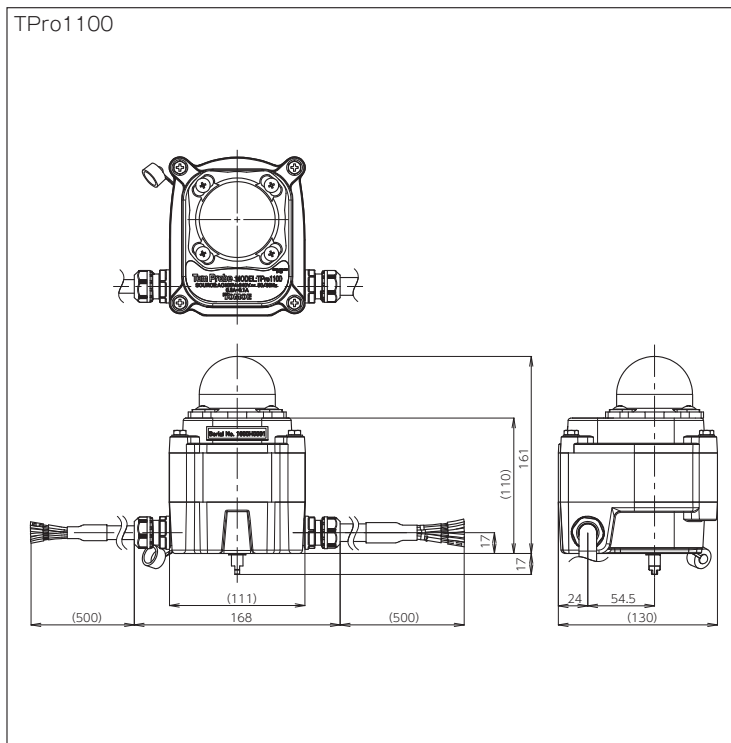

## Tom Probe

is a newly-coined term that comes from our company name "Tomoe Valve", combined with "Probe". Probe means investigation or examination. It also refers to a device for checking the status of a target object.

Thus, Tom Probe is the name of a series of Tomoe Valve products which include devices which probe valve status.

## TOMOE VALVE CO., LTD. [www.tomoevalve.com](http://www.tomoevalve.com)

●Head Office  
3-11-11 Shinmachi, Nishi-ku, Osaka 550-0013, Japan  
Telephone: 81-6-6110-2101/2102/2103 Telefax: 81-6-6110-2105/2106 E-mail: sales@tomoevalve.com

### Global Sales Operations

**TOMOE VALVE INDUSTRY (NANTONG) CO., LTD.** [www.tomoe.sh.cn](http://www.tomoe.sh.cn)  
Room 1102, Building A, St.NOAH Plaza, No.1759 Jinshajiang Road, Putuo district, Shanghai. 200333, China  
Telephone: +86-21-52715628 Telefax: +86-21-52653691 E-mail: sales@tomoe.sh.cn

**TOMOE VALVE ASIA PACIFIC PTE. LTD.** [www.tomoe.com.sg](http://www.tomoe.com.sg)  
No 2, Toh Guan Road East, #02-02, Singapore 608837  
Telephone: +65-68995060 Telefax: +65-68995061 E-mail: sales@tomoe.com.sg

**TOMOE VALVE (THAILAND) CO., LTD.**  
No. 317, Kamol Sukosol Building, Unit B, 12th Floor, Silom Road, Silom Sub-district, Bangrak District, Bangkok 10500, Thailand  
Telephone: +66-(0)-2117-0429 Telefax: +66-(0)-2117-0148 E-mail: sales@tomoe.co.th

**TOMOE VALVE LIMITED** [www.tomoeurope.co.uk](http://www.tomoeurope.co.uk)  
Clearwater Road, Queensway Meadows Industrial Estate, Newport, South Wales NP19 4ST, United Kingdom  
Telephone: 44-1633-636800 Telefax: 44-1633-636801 E-mail: sales@tomoe.co.uk

**PT. TOMOE VALVE BATAM** [www.tomoe-batam.com](http://www.tomoe-batam.com)  
BlockF2 Latrade Industrial Park, Jl. Sei Binti Tanjung Uncang, Batam 29422 Indonesia  
Telephone: +62-778-395-466 Telefax: +62-778-396-475 E-mail: sales@tomoe-batam.com

**TOMOE USA Inc.**  
15700 International Plaza Drive Suite150, Houston TX, 77032 USA  
Telephone: +1-281-358-7571 Telefax: +1-281-358-7861